

MZ-C-T-26

T-Nut-Adapter
T-groove adapter
Adaptateur pour rainure en T

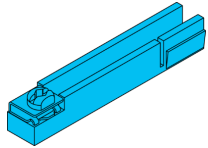

di-soric GmbH & Co. KG
Steinbeisstraße 6
DE-73660 Urbach
Germany
Tel: +49 (0) 7181/9879-0
info@di-soric.com · www.di-soric.com

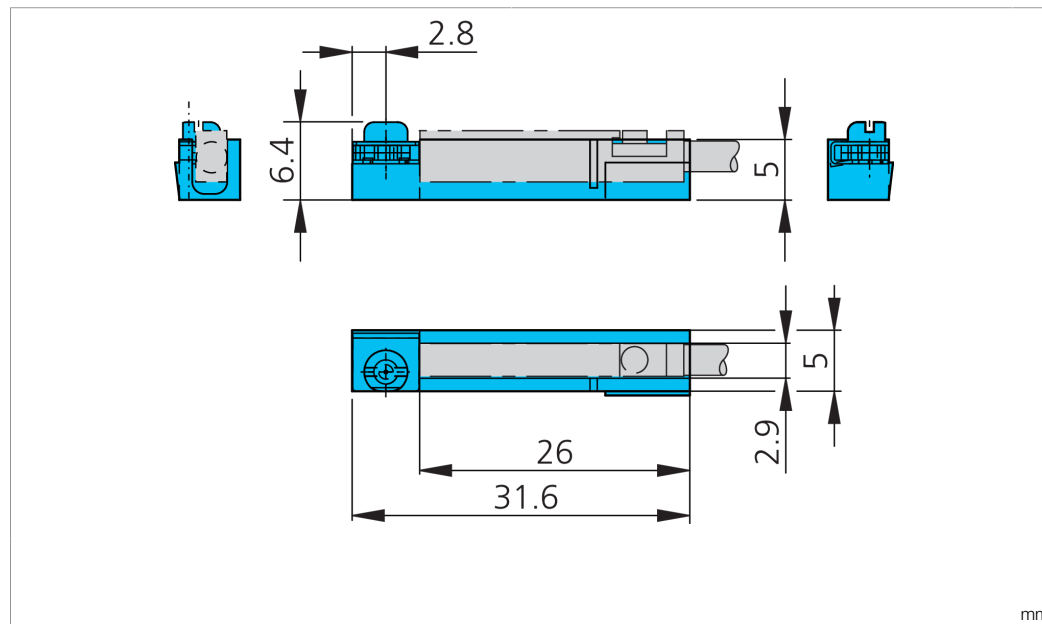

Technische Daten	Technical data	Caractéristiques techniques	
Montage	Assembly	Montage	an Zylindersensoren mit T-Nut / to cylinder sensors with T-groove / Aux détecteurs pour vérins avec rainure en T
Geeignet für	To be used for	Convient pour	Zylindersensoren MZEC 9-26... / Cylinder sensors MZEC 9-26... / Détecteurs pour vérins MZEC 9-26...
Material	Material	Matériau	Zinkdruckguss, Edelstahl / Die-cast zinc, Stainless steel / Zinc moulé sous pression, Acier inoxydable
Lieferumfang	Scope of delivery	Contenu de la livraison	Adapter / Adapter / Adaptateur

Stand 06.02.24, Änderungen vorbehalten
As of 02/06/24, subject to change
État 06.02.24, sous réserve de modifications



MZ-C-T-26

T 型槽适配器

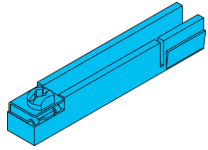

di-soric GmbH & Co. KG
 Steinbeisstraße 6
 DE-73660 Urbach
 Germany
 Tel: +49 (0) 7181/9879-0
 info@di-soric.com · www.di-soric.com

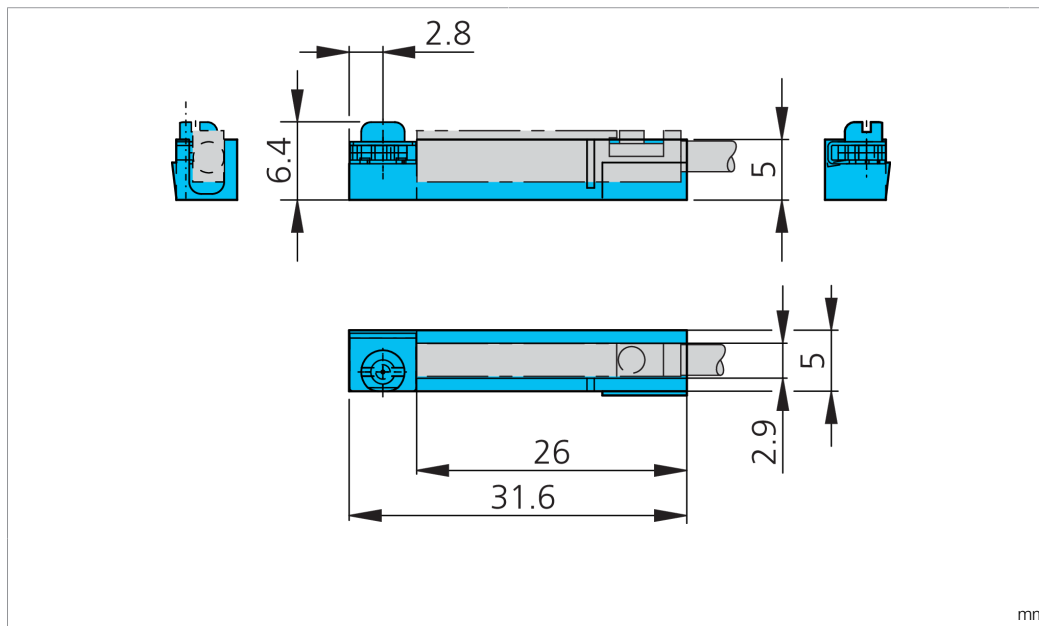

技术数据

装配

在带 T 型槽的气缸传感器上

适合用于

气缸传感器 MZEC 9-26...

材料

锌压铸件, 不锈钢

供货范围

转接器

版本 24.02.06, 保留变更权

